



MODEL W1793/W1794 PROFESSIONAL SPRAY GUN



W1793
(LVLP)



W1794
(HVLP)

OWNER'S MANUAL

Phone: (360) 734-3482 • Online Technical Support: tech-support@shopfox.biz

COPYRIGHT © JUNE, 2007 BY WOODSTOCK INTERNATIONAL, INC.
WARNING: NO PORTION OF THIS MANUAL MAY BE REPRODUCED IN ANY SHAPE OR FORM WITHOUT
THE WRITTEN APPROVAL OF WOODSTOCK INTERNATIONAL, INC.

#9624CR PRINTED IN CHINA

 **WARNING!**

This manual provides critical safety instructions on the proper setup, operation, maintenance and service of this machine/equipment.

Failure to read, understand and follow the instructions given in this manual may result in serious personal injury, including amputation, electrocution or death.

The owner of this machine/equipment is solely responsible for its safe use. This responsibility includes but is not limited to proper installation in a safe environment, personnel training and usage authorization, proper inspection and maintenance, manual availability and comprehension, application of safety devices, blade/cutter integrity, and the usage of personal protective equipment.

The manufacturer will not be held liable for injury or property damage from negligence, improper training, machine modifications or misuse.

 **WARNING!**

Some dust created by power sanding, sawing, grinding, drilling, and other construction activities contains chemicals known to the State of California to cause cancer, birth defects or other reproductive harm. Some examples of these chemicals are:

- Lead from lead-based paints.
- Crystalline silica from bricks, cement and other masonry products.
- Arsenic and chromium from chemically-treated lumber.

Your risk from these exposures varies, depending on how often you do this type of work. To reduce your exposure to these chemicals: Work in a well ventilated area, and work with approved safety equipment, such as those dust masks that are specially designed to filter out microscopic particles.

SAFETY

WARNING

For Your Own Safety Read Instruction Manual Before Operating This Equipment

The purpose of safety symbols is to attract your attention to possible hazardous conditions. This manual uses a series of symbols and signal words which are intended to convey the level of importance of the safety messages. The progression of symbols is described below. Remember that safety messages by themselves do not eliminate danger and are not a substitute for proper accident prevention measures.



Indicates an imminently hazardous situation which, if not avoided, **WILL** result in death or serious injury.



Indicates a potentially hazardous situation which, if not avoided, **COULD** result in death or serious injury.



Indicates a potentially hazardous situation which, if not avoided, **MAY** result in minor or moderate injury. It may also be used to alert against unsafe practices.

NOTICE

This symbol is used to alert the user to useful information about proper operation of the equipment.

WARNING

Safety Instructions for Pneumatic Tools

1. **KEEP ALL SAFETY DEVICES IN PLACE** and in working order.
2. **REMOVE ADJUSTING KEYS AND WRENCHES.** Form habit of checking to see that keys and adjusting wrenches are removed from tool before operation.
3. **KEEP WORK AREA CLEAN.** Cluttered areas and benches invite accidents.
4. **DO NOT USE IN DANGEROUS ENVIRONMENT.** Do not use pneumatic tools in damp or wet locations, or where any flammable or noxious fumes may exist. Keep work area well lighted.
5. **KEEP CHILDREN AND VISITORS AWAY.** All children and visitors should be kept at a safe distance from work area.
6. **MAKE WORKSHOP CHILD PROOF** by locking your shop and shutting off air valves.
7. **DO NOT FORCE TOOL.** It will do the job better and safer at the rate for which it was designed.
8. **USE THE RIGHT TOOL.** Do not force tool or attachment to do a job for which it was not designed.
9. **DO NOT USE UNDER THE INFLUENCE OF DRUGS OR ALCOHOL.**

WARNING

Safety Instructions for Pneumatic Tools

10. **USE PROPER AIR HOSE** for the tool. Make sure your air hose is in good condition and is long enough to reach your work without stretching.
11. **WEAR PROPER APPAREL.** Do not wear loose clothing, gloves, neckties, rings, bracelets, or other jewelry which may get caught in moving parts. Non-slip footwear is recommended. Wear a protective hair covering to contain long hair.
12. **ALWAYS USE SAFETY GLASSES.** Also use a face or dust mask if cutting operation is dusty. Everyday eyeglasses only have impact resistant lenses, they are NOT safety glasses.
13. **WEAR APPROVED HEARING PROTECTION.** Air escaping from pneumatic tools can exceed safe exposure limits and may cause hearing damage with prolonged exposure.
14. **SECURE WORK.** Use clamps or a vise to hold work when practical. It is safer than using your hand and frees both hands to operate tool.
15. **MAINTAIN TOOLS WITH CARE.** Keep tools lubricated and clean for best and safest performance. Follow instructions for lubricating and changing accessories.
16. **REDUCE THE RISK OF UNINTENTIONAL FIRING.** Do not carry tool with hand on trigger and always disconnect from air when not in use.
17. **DISCONNECT TOOLS** before servicing, changing accessories, or moving to another location.
18. **DO NOT OVERREACH.** Keep proper footing/balance at all times.
19. **USE THE RECOMMENDED ACCESSORIES.** Consult owner's manual for recommended accessories. The use of improper accessories may cause risk of injury.
20. **CHECK FOR DAMAGED PARTS BEFORE USING.** Check for binding and alignment of parts, broken parts, part mounting, loose bolts, and any other conditions that may affect machine operation. Repair or replace damaged parts.
21. **NEVER LEAVE UNATTENDED TOOL CONNECTED TO AIR.** Disconnect the air hose and do not leave tool until it is relieved of any built up pressure.
22. **NEVER ALLOW UNTRAINED USERS TO USE THIS TOOL WHILE UNSUPERVISED.**
23. **IF YOU ARE UNSURE OF THE INTENDED OPERATION, STOP USING TOOL.** Seek formal training or research books or magazines that specialize in pneumatic tools.
24. **BE AWARE OF HOSE LOCATION WHEN USING PNEUMATIC TOOLS.** Hoses can easily become a tripping hazard when laid across the floor or spread out in a disorganized fashion.

WARNING

Additional Safety Instructions for Spray Guns

- 1. READ THIS MANUAL.** This manual contains proper operating instructions for this spray gun.
- 2. READ MATERIAL LABELS and MATERIAL SAFETY DATA SHEETS (MSDS).** Read and know all the instructions on the packaging label and the MSDS before opening the package. This information could save your life.
- 3. ALWAYS WEAR A NIOSH APPROVED RESPIRATOR WHEN SPRAYING OR WORKING AROUND FINISHING MATERIALS.**
- 4. FIRE EXTINGUISHERS.** Always have a fully charged multi class or class B fire extinguisher in the immediate area.
- 5. FLAMMABLE MATERIAL. NEVER** spray near open flame or where any spark could occur.
- 6. FRESH AIR.** Always provide adequate exhaust to keep area free of built up vapors, NEVER spray in an enclosed space.
- 7. DISCONNECT COMPRESSED AIR.** Always disconnect the spray gun from compressed air before cleaning, changing attachments or when performing maintenance of any kind on this tool.
- 8. PROTECTIVE CLOTHING.** Protect exposed skin from overspray by wearing a protective suit or other approved garment.
- 9. INAPPROPRIATE USE. DO NOT** point or shoot spray gun directly at yourself or another person or animals. Do not attempt to use the spray gun for any other use than it was intended.
- 10. STORAGE.** Thoroughly clean and dry spray gun before storage. Store in an approved cabinet.
- 11. SOLVENTS.** Always store solvents and shop towels soaked in solvent in approved containers.
- 12. EYE PROTECTION.** Wear eye protection whenever spraying or cleaning. Solvents and chemicals can cause serious eye injury, which could lead to blindness.
- 13. OPERATING PRESSURE. DO NOT** exceed the recommended inlet air pressure. Excessive pressure could cause the spray gun to burst or cause other internal equipment damage.
- 14. LOCAL LAWS.** Consult local authorities regarding exhaust and waste disposal requirements.

CAUTION

No list of safety guidelines can be complete. Every shop environment is different. Always consider safety first, as it applies to your individual working conditions. Use this and other tools with caution and respect to avoid serious injury.

INTRODUCTION

Woodstock Technical Support

This machine has been specially designed to provide many years of trouble-free service. Close attention to detail, ruggedly built parts and a rigid quality control program assure safe and reliable operation.

Woodstock International, Inc. is committed to customer satisfaction. Our intent with this manual is to include the basic information for safety, setup, operation, maintenance, and service of this product.

We stand behind our tools! In the event that questions arise about your machine, please contact Woodstock International Technical Support at (360) 734-3482 or send e-mail to: tech-support@shopfox.biz. Our knowledgeable staff will help you troubleshoot problems and process warranty claims.

If you need the latest edition of this manual, you can download it from <http://www.shopfox.biz>.

If you have comments about this manual, please contact us at:

Woodstock International, Inc.
Attn: Technical Documentation
Manager

P.O. Box 2309
Bellingham, WA 98227
Email: manuals@woodstockint.com

W1793 Specifications

Type..... LVLP Gravity Feed
Fluid Tip..... 1.5 mm
Air Consumption3-3.9 CFM
Inlet Air Pressure 2-3.5 Bar /29-50 PSI
Fluid Pressure Greater Than 10 PSI
Material Capacity 600 ml / 20 fl oz
Pattern Width 180-280 mm

W1794 Specifications

Type..... HVLP Gravity Feed
Fluid Tip..... 1.4 mm
Air Consumption 4.2-7.1 CFM
Inlet Air Pressure 2-3.5 Bar /29-50 PSI
Fluid Pressure Greater Than 10 PSI
Material Capacity 600 ml / 20 fl oz
Pattern Width 180-250 mm

WARNING

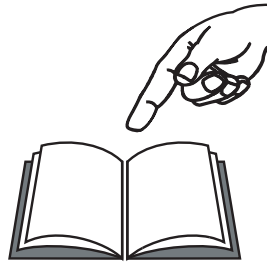

Read manual before operation. Become familiar with the spray gun safety and operation instructions before beginning any work. Serious personal injury may result if safety or operational information is not understood or followed.

SETUP

Unpacking

This tool has been carefully packaged for safe transportation. If you notice the tool has been damaged during shipping, please contact your authorized Shop Fox dealer immediately.

Inventory

The following is a description of the main components shipped with the Model W1793/ W1794. Lay the components out to inventory them.

Note: *If you can't find an item on this list, check the mounting location on the tool or examine the packaging materials carefully. Occasionally we pre-install certain components for safer shipping.*

W1793 Inventory (Figure 4)	Qty
A. Service Wrench.....	1
B. Spray Gun	1
C. Filter	2
D. Cup 600 ml.....	1
E. Cleaning Brush.....	1
F. Bore Brush	1
G. Hose Fitting	1

W1794 Inventory (Figure 5)	Qty
A. Service Wrench.....	1
B. Bore Brush	1
C. Baffle Wrench	1
D. Spray Gun	1
E. Filter	2
F. Cup 600 ml.....	1
G. Regulator/Gauge.....	1

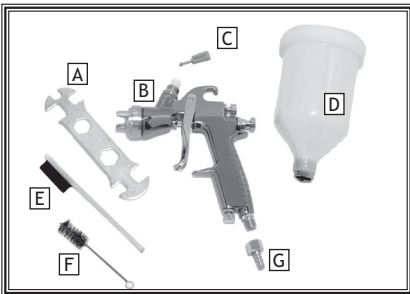

Figure 4. Model W1793 inventory.

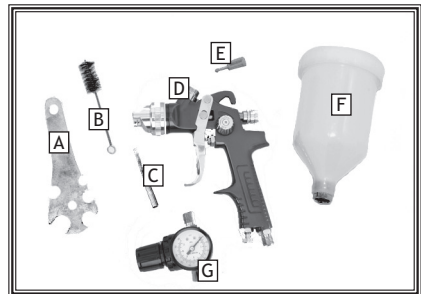

Figure 5. Model W1794 inventory.

Assembly

1. Insert the filter into the gun body (see Figure 6).

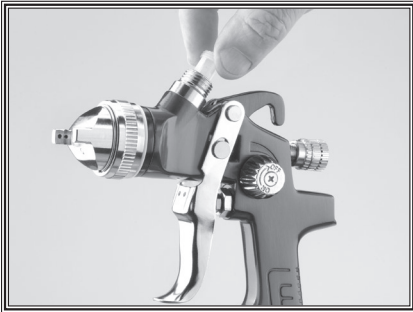

Figure 6. Installing filter.

2. Screw the cup onto the top of the body.
3. Attach the air hose to the spray gun with a 1/4" NPT quick connect set-up (not included).

Note: You have the option of attaching the regulator/gauge directly to the gun as shown in the photos. Some may find this awkward and would rather mount the regulator/gauge closer to the air source.

4. Attach the spray gun to an air hose regulated between 29 and 50 PSI.

Note: For the best results, use a hose that will be dedicated for spray use only. Do not use a hose that has been used with an in-line oiler or other possible contaminant.

Controls

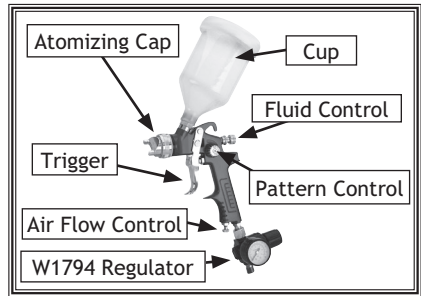

Figure 7. Controls.

1. **Fluid Control:** Controls the volume of material that travels through the fluid tip.
2. **Pattern Control:** Adjusts the spray pattern from a round pattern to a wide fan.
3. **Air Flow Control:** Controls the fluid pressure inside the spray gun.
4. **Atomizing Cap:** Controls the spray pattern from vertical to horizontal.
5. **Trigger:** Two stage trigger. Stage one only releases compressed air for blowing off the work piece. Stage two sprays material.
6. **Cup:** 600 ml plastic cup allows easy viewing of material level. Includes a vented cap.
7. **Regulator/Gauge:** Regulates inlet air pressure to the spray gun. On either spray gun, the regulator can be attached directly to the gun for on-the-spot air adjustments or directly from the air source. On either spray gun, DO NOT attach to an unregulated air source that exceeds 120 PSI.

Note: The W1793 spray gun regulator must be purchased separately.

OPERATIONS

! DANGER



EXPLOSION HAZARD! DO NOT smoke or have any source of flame or spark near spraying. Vapors will explode if ignited.

! WARNING



RESPIRATORY HAZARD! Always use respirator rated for organic vapor and solvent use when using spray equipment. Failure to protect your lungs can lead to respiratory illness and nervous system damage.

! WARNING



TOXIC FUMES! Always use an approved spray booth or well ventilated area when spraying. **NEVER** spray in a confined space where toxic fumes and flammable vapors can accumulate to deadly levels.

Spraying

The Model W1793/W1794 spray gun is designed to spray low to medium viscosity liquids, like lacquers, stains, primers, multi-component paints, acrylics, epoxies etc. It is ideal for auto body touch-ups, woodworking projects, or projects with hard to reach areas.

To use your spray gun:

1. Read and follow the material manufacturer's instructions for spraying, mixing, safety, disposal, and any other instruction on the label or Material Safety Data Sheet (MSDS).
2. Ensure the cup is securely tightened and all other fittings are secure to avoid air leaks or material spills.
3. Set the inlet air pressure (the air coming to the spray gun) to the lowest pressure recommended in **Specifications on Page 4** or to the material manufacturer's recommendations.
4. Adjust the atomizing cap to vertical or horizontal. See **Atomizing Cap and Fan Adjustments on Page 9** for further explanation.
5. Fill the cup with material.
6. Trial and error are necessary to achieve the results you want along with a fair amount of practice. Test your material flow and spray pattern on a piece of cardboard or some scrap of material similar to your project.

7. Adjust the fluid control knob to start with a low volume of material and keep the atomization as low as possible. You will need to use a combination of fluid control, inlet air pressure, air flow control and stroke speed to achieve the results you want. Spray so the material wets out nicely without running or sagging.
8. Use the pattern control knob to adjust the spray fan to your desired pattern.
9. Keep the gun tip perpendicular, parallel, and 6-8" from the work (as shown in **Figure 8**) when spraying. Do not allow your wrist to bend. This will cause the gun to arc across the surface and distribute the material unevenly, possibly creating sags and dry spots.

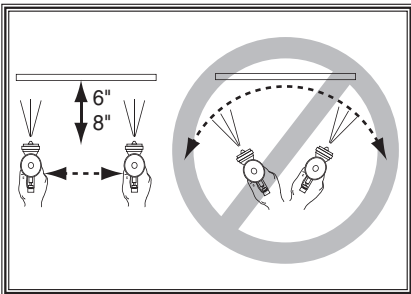

Figure 8. Spray technique.

10. Begin spraying 2-3 inches before the work piece and continue to the end of the work piece. Continue the motion for a few inches past the work until you are ready for the return stroke.
11. Maintain an even speed when spraying.
12. Overlap each stroke by 50%. This will ensure even coverage, as shown in **Figure 9**. Overlapping less than 50%, as shown in the figure to the right, may lead to missed spots or streaky results.

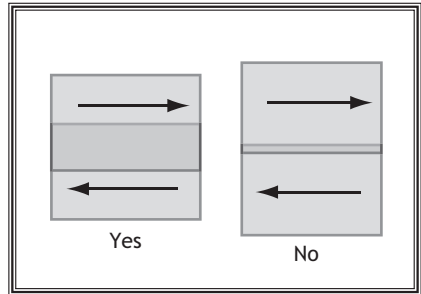

Figure 9. Overlap technique.

13. Spray stroke should have even consistency and parallel edges. If it doesn't, refer to **Troubleshooting** on **Page 12**.

NOTICE

Tipping spray gun may cause material to spill out of the cup. Always hold the spray gun perpendicular to the ground to avoid potential spills and gravity feed problems.

Atomizing Cap and Fan Adjustments

The atomizing cap needs to be adjusted for horizontal or vertical spraying patterns. Spraying in the wrong direction may lead to material build up on the atomizing cap horn. Many performance problems are caused by clogged atomizing holes on the atomizing cap horns (see **Cleaning** on **Page 10**).

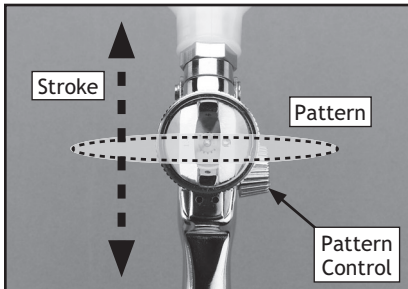

Figure 10. Set up for vertical spray stroke with horizontal fan pattern.

Rotating the pattern adjustment control in **Figure 11** will give you a range between the two patterns in **Figure 12**.

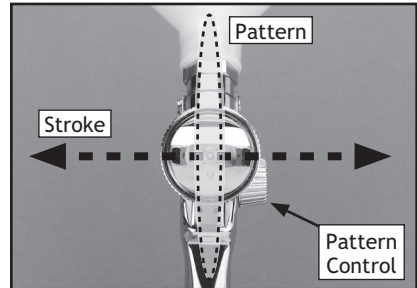

Figure 11. Set up for horizontal stroke direction with vertical fan pattern.

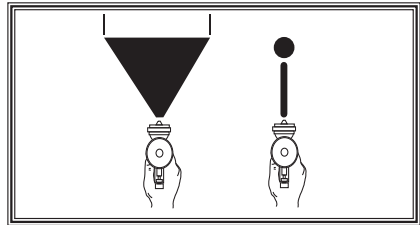

Figure 12. Fan adjustment.

CLEANING & LUBRICATION

Cleaning

Proper cleaning is the best way to ensure trouble free performance from your spray gun. If your gun is not thoroughly cleaned, damage and poor spraying will result. Problems caused by improper cleaning will not be covered by the warranty. Clean the spray gun immediately after each use.

To clean your spray gun:

1. Spray a small amount of solvent through the spray gun.

Note: Check with local laws regarding this practice. If you are spraying on a regular basis, spraying solvents into the air may be illegal. A cabinet style spray gun cleaner may be required.

2. DISCONNECT SPRAY GUN FROM AIR!
3. Unscrew the cup.
4. Disassemble the gun by unscrewing the fluid control knob, removing the spring and needle (Figure 13).

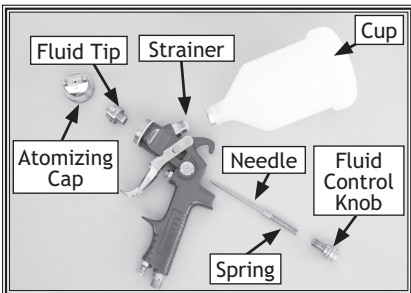

Figure 13. Gun disassembled for cleaning.

5. Unscrew the atomizing cap with your fingers and the fluid tip with the service wrench. The fully disassembled gun should look like Figure 13.
6. Rinse these parts thoroughly in solvent then dry with compressed air or let air dry.

Note: If the small holes in the atomizing cap become blocked, soak in cleaning solvent. If the blockage still exists, clear the blockage with a small needle, taking great care to not enlarge or damage the hole. Damage to the hole will create a disrupted spray pattern.

7. Use the cleaning brush with solvent to clean the inner orifice and other hard to reach areas on the outside of the spray gun body.
8. Wipe the rest of the gun body with a shop towel and dry.

⚠ WARNING

EXPLOSION HAZARD! Chlorinated Solvents like Trichloroethane and Methylene Chloride (methyl chloride) can chemically react with aluminum and may explode. Many parts in spray guns are made of aluminum. Read solvent label carefully before using solvent.

NOTICE

DO NOT soak the spray gun body in solvent. Prolonged exposure to solvent will rapidly deteriorate the spray gun washers and seals. Ignoring this notice will void your warranty.

Lubrication

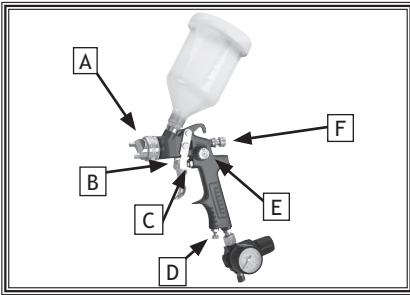







Figure 14. Lubrication points.

Lubricate the following areas with spray gun lube after cleaning:

- A. Atomizing Cap Threads
- B. Air Valve Packing
- C. Trigger Pin
- D. Air Flow Control Valve
- E. Pattern Control
- F. Fluid Control Knob

After each cleaning, apply a thin film of petroleum jelly to the needle spring before reassembling.

Troubleshooting

Symptom	Possible Cause	Possible Solution
Fluttering or Spitting spray. 	<ol style="list-style-type: none"> 1. Dry or worn fluid tip seat permits air to seep into fluid passage. 2. Material level too low. 3. Fluid tip or strainer obstructed. 4. Dry needle packing. 	<ol style="list-style-type: none"> 1. Tighten fluid tip or replace seat with new one. 2. Add material. 3. Clean. 4. Lubricate needle.
Uneven top or bottom pattern. 	<ol style="list-style-type: none"> 1. Atomizing cap holes are obstructed. 2. Build-up on top or bottom of fluid tip. 3. Build-up on atomizing cap is on needle seat. 	<ol style="list-style-type: none"> 1. Clear holes. 2. Clean. 3. Clean.
Right or left arc pattern. 	<ol style="list-style-type: none"> 1. Left or right side horn holes are plugged. 2. Build-up on left or right side of fluid tip. 3. Build-up of material inside atomizing cap. 	<ol style="list-style-type: none"> 1. Clear holes. 2. Clean. 3. Clean.
Heavy deposit of material in center. 	<ol style="list-style-type: none"> 1. The material flow exceeds the atomizing cap capacity. 2. Inlet air pressure is too low. 3. Material is too thick. 	<ol style="list-style-type: none"> 1. Lower fluid flow. 2. Increase inlet air pressure. 3. Thin material.
Narrow center pattern. 	<ol style="list-style-type: none"> 1. Volume control turned in too far. 2. Inlet air pressure too high. 3. Fluid pressure is too low. 4. Material is too thin. 	<ol style="list-style-type: none"> 1. Increase volume. 2. Reduce inlet air pressure. 3. Increase fluid pressure. 4. Adjust material.
No spray output.	<ol style="list-style-type: none"> 1. No pressure at gun. 2. Fluid passages dirty. 3. Fluid control closed. 4. Out of paint. 	<ol style="list-style-type: none"> 1. Check air supply. 2. Clean gun, remove any obstructions. 3. Open. 4. Refill.



Symptom	Possible Cause	Possible Solution
Excessive over-spray.	<ol style="list-style-type: none"> 1. Fluid pressure too high. 2. Gun is too far from surface. 3. Spraying too fast. 	<ol style="list-style-type: none"> 1. Reduce fluid pressure. 2. Keep gun at recommended distance. 3. Slow down and maintain consistent, even parallel stroke.
Unable to control spray fan.	<ol style="list-style-type: none"> 1. Pattern adjustment screw is not seating properly. 2. Atomizing cap is loose. 	<ol style="list-style-type: none"> 1. Clean or replace. 2. Tighten atomizing cap.
Runs and sags.	<ol style="list-style-type: none"> 1. Damaged seal. 	<ol style="list-style-type: none"> 1. Replace damaged seals.
Material leaks from cup.	<ol style="list-style-type: none"> 1. Cap not secure. 2. Cup not tight on gun body. 3. Leaking from cap vent hole. 	<ol style="list-style-type: none"> 1. Tighten. 2. Tighten. 3. Hold gun upright do not tilt.
Material leaks from gun.	<ol style="list-style-type: none"> 1. Fluid tip loose. 2. Dry or damaged seals. 3. Excessive pressure. 	<ol style="list-style-type: none"> 1. Tighten. 2. Replace seals. 3. Reduce pressure.
Thick dimpled finish aka "Orange Peel."	<ol style="list-style-type: none"> 1. Holding gun too close to surface. 2. Inlet air pressure too low. 3. Material not properly mixed. 4. Surface is dirty or oily. 	<ol style="list-style-type: none"> 1. Spray at recommended distance. 2. Check inlet air pressure. 3. Follow manufacturer's instructions. 4. More surface prep is required.
Dry Spray.	<ol style="list-style-type: none"> 1. Inlet air pressure too high. 2. Gun too far from surface. 3. Gun stroke too fast. 	<ol style="list-style-type: none"> 1. Lower inlet air pressure. 2. Keep gun at recommended distance. 3. Slow down and maintain consistent even parallel stroke.
Gun leaks from fluid tip.	<ol style="list-style-type: none"> 1. Debris will not let the needle seat with the fluid tip. 	<ol style="list-style-type: none"> 1. Clean or replace both.
Contaminated paint.	<ol style="list-style-type: none"> 1. Water or oil in the air line. 	<ol style="list-style-type: none"> 1. Install an in-line air filter. 2. Replace air line.

W1793 PARTS LIST

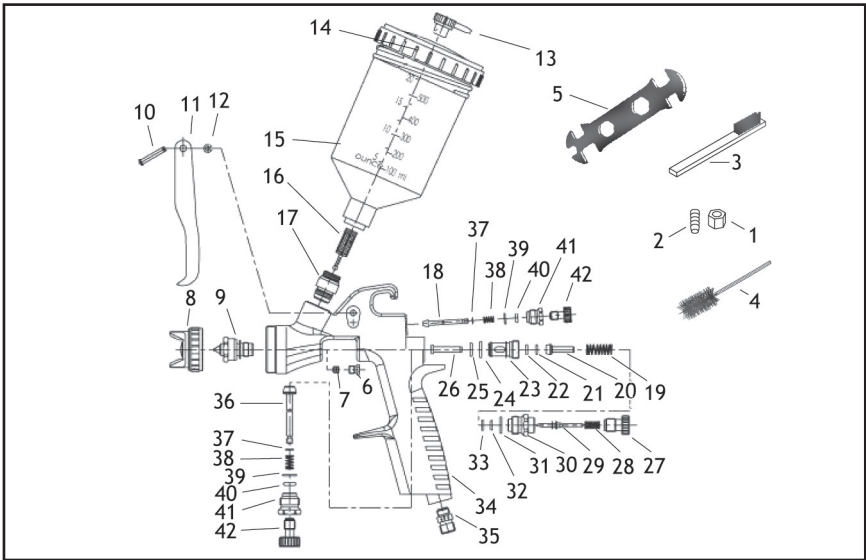

REF	PART #	DESCRIPTION
1	X1793001	LOCK NUT
2	X1793002	HOSE FITTING
3	X1793003	CLEANING BRUSH
4	X1793004	BORE BRUSH
5	X1793005	SERVICE WRENCH
6	X1793006	DIRECTION SCREW
7	X1793007	SEAL WASHER
8	X1793008	AIR CAP
9	X1793009	FLUID NOZZLE
10	X1793010	TRIGGER LEVER
11	X1793011	TRIGGER
12	X1793012	SPECIAL WASHER
13	X1793013	VENTILATOR HEAD
14	X1793014	CUP LID
15	X1793015	CUP
16	X1793016	FILTER
17	X1793017	FLUID INLET JOINT
18	X1793018	INLET VALVE
19	X1793019	SWITCH SPRING
20	X1793020	O-RING 4.5 X 1.2
21	X1793021	O-RING 4.5 X 1.2
22	X1793022	WASHER

REF	PART #	DESCRIPTION
23	X1793023	NEEDLE SLEEVE
24	X1793024	O-RING 10.7 X 1.8
25	X1793025	O-RING 8.5 X 1.2
26	X1793026	SWITCH POLE
27	X1793027	NEEDLE ADJ. SCREW
28	X1793028	NEEDLE SPRING
29	X1793029	NEEDLE SCREW
30	X1793030	NEEDLE KNOB
31	X1793031	O-RING 8.7 X 1.85
32	X1793032	O-RING 4.5 X 1.8
33	X1793033	SPECIAL WASHER
34	X1793034	GUN BODY
35	X1793035	AIR INLET
36	X1793036	INLET VALVE
37	X1793037	SPECIAL WASHER
38	X1793038	AIR VALVE SPRING
39	X1793039	SPECIAL WASHER
40	X1793040	O-RING 3.3 X 1.5
41	X1793041	ADJ. KNOB
42	X1793042	ADJ. SCREW
43	X1793042	O-RING KIT

W1794 PARTS LIST

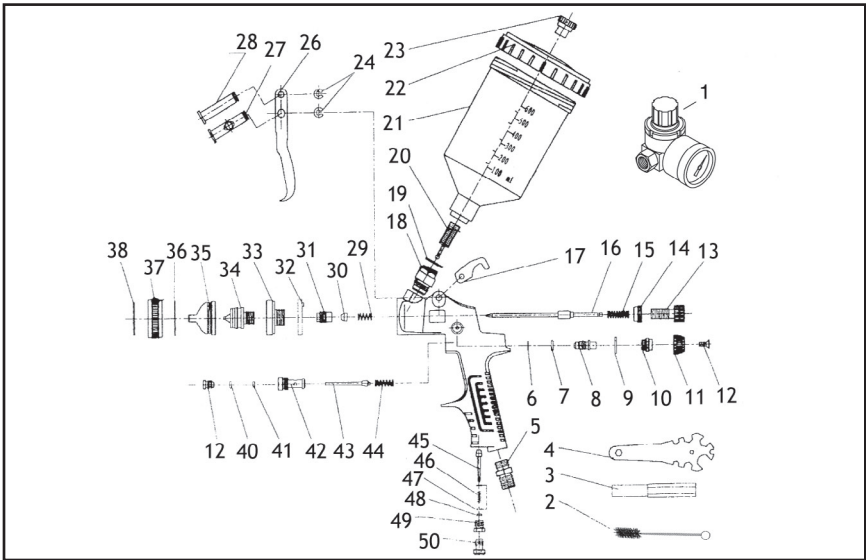

REF	PART #	DESCRIPTION
1	X1794001	AIR REGULATOR
2	X1794002	BORE BRUSH
3	X1794003	BAFFLE WRENCH
4	X1794004	TOOL WRENCH
5	X1794005	AIR INLET JOINT
6	X1794006	RETAINER
7	X1794007	O-RING 6 X 2
8	X1794008	PATTERN ADJ SCREW
9	X1794009	SPECIAL WASHER
10	X1794010	PATTERN ADJ KNOB
11	X1794011	PATTERN ADJ
12	X1794012	FLAT HEAD SCREW
13	X1794013	FLUID ADJ KNOB
14	X1794014	SEALING CUP
15	X1794015	FLUID NEEDLE SPRING
16	X1794016	FLUID ADJ NEEDLE
17	X1794017	HOOK
18	X1794018	FLUID INLET JOINT
19	X1794019	INLET WASHER
20	X1794020	FILTER
21	X1794021	CUP 600ML
22	X1794022	CUP COVER
23	X1794023	VENTILATOR HEAD
24	X1794024	RETAINER 4MM
26	X1794026	TRIGGER

REF	PART #	DESCRIPTION
27	X1794027	TRIGGER LEVER 2
28	X1794028	TRIGGER LEVER 1
29	X1794029	LOCKING SPRING
30	X1794030	PAINT NEEDLE WASHER
31	X1794031	DIRECTION SCREW
32	X1794032	BAFFLE WASHER
33	X1794033	BAFFLE
34	X1794034	FLUID NOZZLE 1.4MM
35	X1794035	ATOMIZATION CAP
36	X1794036	FLUID CAP WASHER
37	X1794037	CAP NUT
38	X1794038	PIN SPRING
39	X1794039	DIRECTION SCREW
40	X1794040	SPECIAL WASHER
41	X1794041	O-RING 8.5 X 1.2
42	X1794042	SWITCH KNOB
43	X1794043	AIR VALVE BODY
44	X1794044	SWITCH SPRING
45	X1794045	AIR INLET VALVE
46	X1794046	AIR VALVE SPRING
47	X1794047	SPECIAL WASHER
48	X1794048	O-RING 2.5 X 2.1
49	X1794049	AIR ADJUSTMENT KNOB
50	X1794050	AIR ADJUSTMENT SCREW
51	X1794051	O-RING KIT

WARRANTY AND RETURNS

Woodstock International, Inc. warrants all Shop Fox machinery to be free of defects from workmanship and materials for a period of two years from the date of original purchase by the original owner. This warranty does not apply to defects due directly or indirectly to misuse, abuse, negligence or accidents, lack of maintenance, or reimbursement of third party expenses incurred.

Woodstock International, Inc. will repair or replace, at its expense and at its option, the Shop Fox machine or machine part which in normal use has proven to be defective, provided that the original owner returns the product prepaid to a Shop Fox factory service center with proof of their purchase of the product within two years, and provides Woodstock International, Inc. reasonable opportunity to verify the alleged defect through inspection. If it is determined there is no defect, or that the defect resulted from causes not within the scope of Woodstock International Inc.'s warranty, then the original owner must bear the cost of storing and returning the product.

This is Woodstock International, Inc.'s sole written warranty and any and all warranties that may be implied by law, including any merchantability or fitness, for any particular purpose, are hereby limited to the duration of this written warranty. We do not warrant that Shop Fox machinery complies with the provisions of any law or acts. In no event shall Woodstock International, Inc.'s liability under this warranty exceed the purchase price paid for the product, and any legal actions brought against Woodstock International, Inc. shall be tried in the State of Washington, County of Whatcom. We shall in no event be liable for death, injuries to persons or property or for incidental, contingent, special or consequential damages arising from the use of our products.

Every effort has been made to ensure that all Shop Fox machinery meets high quality and durability standards. We reserve the right to change specifications at any time because of our commitment to continuously improve the quality of our products.

Warranty Registration

Name _____

Street _____

City _____ State _____ Zip _____

Phone # _____ Email _____ Invoice # _____

Model # _____ Serial # _____ Dealer Name _____ Purchase Date _____

The following information is given on a voluntary basis. It will be used for marketing purposes to help us develop better products and services. Of course, all information is strictly confidential.

1. How did you learn about us?

Advertisement Friend Local Store
 Mail Order Catalog Website Other:

2. How long have you been a woodworker/metalworker?

0-2 Years 2-8 Years 8-20 Years 20+ Years

3. How many of your machines or tools are Shop Fox?

0-2 3-5 6-9 10+

4. Do you think your machine represents a good value? Yes No

5. Would you recommend Shop Fox products to a friend? Yes No

6. What is your age group?

20-29 30-39 40-49
 50-59 60-69 70+

7. What is your annual household income?

\$20,000-\$29,000 \$30,000-\$39,000 \$40,000-\$49,000
 \$50,000-\$59,000 \$60,000-\$69,000 \$70,000+

8. Which of the following magazines do you subscribe to?

<input type="checkbox"/> Cabinet Maker	<input type="checkbox"/> Popular Mechanics	<input type="checkbox"/> Today's Homeowner
<input type="checkbox"/> Family Handyman	<input type="checkbox"/> Popular Science	<input type="checkbox"/> Wood
<input type="checkbox"/> Hand Loader	<input type="checkbox"/> Popular Woodworking	<input type="checkbox"/> Wooden Boat
<input type="checkbox"/> Handy	<input type="checkbox"/> Practical Homeowner	<input type="checkbox"/> Woodshop News
<input type="checkbox"/> Home Shop Machinist	<input type="checkbox"/> Precision Shooter	<input type="checkbox"/> Woodsmith
<input type="checkbox"/> Journal of Light Cont.	<input type="checkbox"/> Projects in Metal	<input type="checkbox"/> Woodwork
<input type="checkbox"/> Live Steam	<input type="checkbox"/> RC Modeler	<input type="checkbox"/> Woodworker West
<input type="checkbox"/> Model Airplane News	<input type="checkbox"/> Rifle	<input type="checkbox"/> Woodworker's Journal
<input type="checkbox"/> Modeltec	<input type="checkbox"/> Shop Notes	<input type="checkbox"/> Other:
<input type="checkbox"/> Old House Journal	<input type="checkbox"/> Shotgun News	

9. Comments: _____

CUT ALONG DOTTED LINE

FOLD ALONG DOTTED LINE

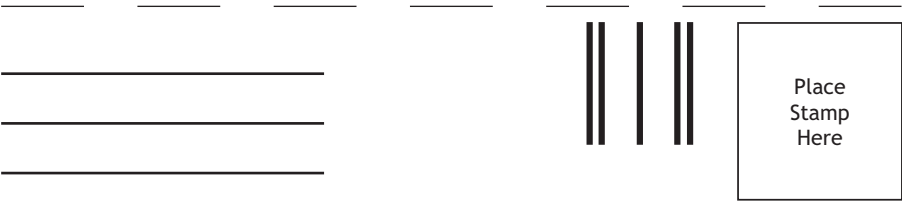

WOODSTOCK INTERNATIONAL INC.
P.O. BOX 2309
BELLINGHAM, WA 98227-2309



FOLD ALONG DOTTED LINE

TAPE ALONG EDGES--PLEASE DO NOT STAPLE